

DATE: 12/21/21

Summary

Name: _____	Job	Rye Town Hall Annex
Addr: _____	Address:	PHASE #1
_____	_____	_____

TAG	QTY	DESCRIPTION	EXTENSION
		WINDOWS	
		Lepage Quote #382849	
		Alum. Clad Exterior: Rainware White	
		Pine Interior: Primer + 1 Coat of White Paint	
		Hardware: Oil Rubbed Broze	
		Screens: Half w/Invisible Mesh	
		4 9/16" Frame Thickness	
		DOORS	
		Lepage Quote # 382898	
		Alum. Clad Exterior	
		Single Door: White	
		Double Door: Black Slabs, with astragal	
		Hardware: See Below	
		Screens: Not Included	
		2 1/4" Slab Thickness	
		4 9/16" Frame Thickness	
		Hardware	
		Emtek	
		Rectangular Push Plate	
		Flat Black	
		Wilshire Pull	
		Qty. 3	
		Rectangluar Deadbolt	
		Single Cylinder	
		Flat Black	
		Qty. 3	



LEPAGE

MILLWORK

True Artisans

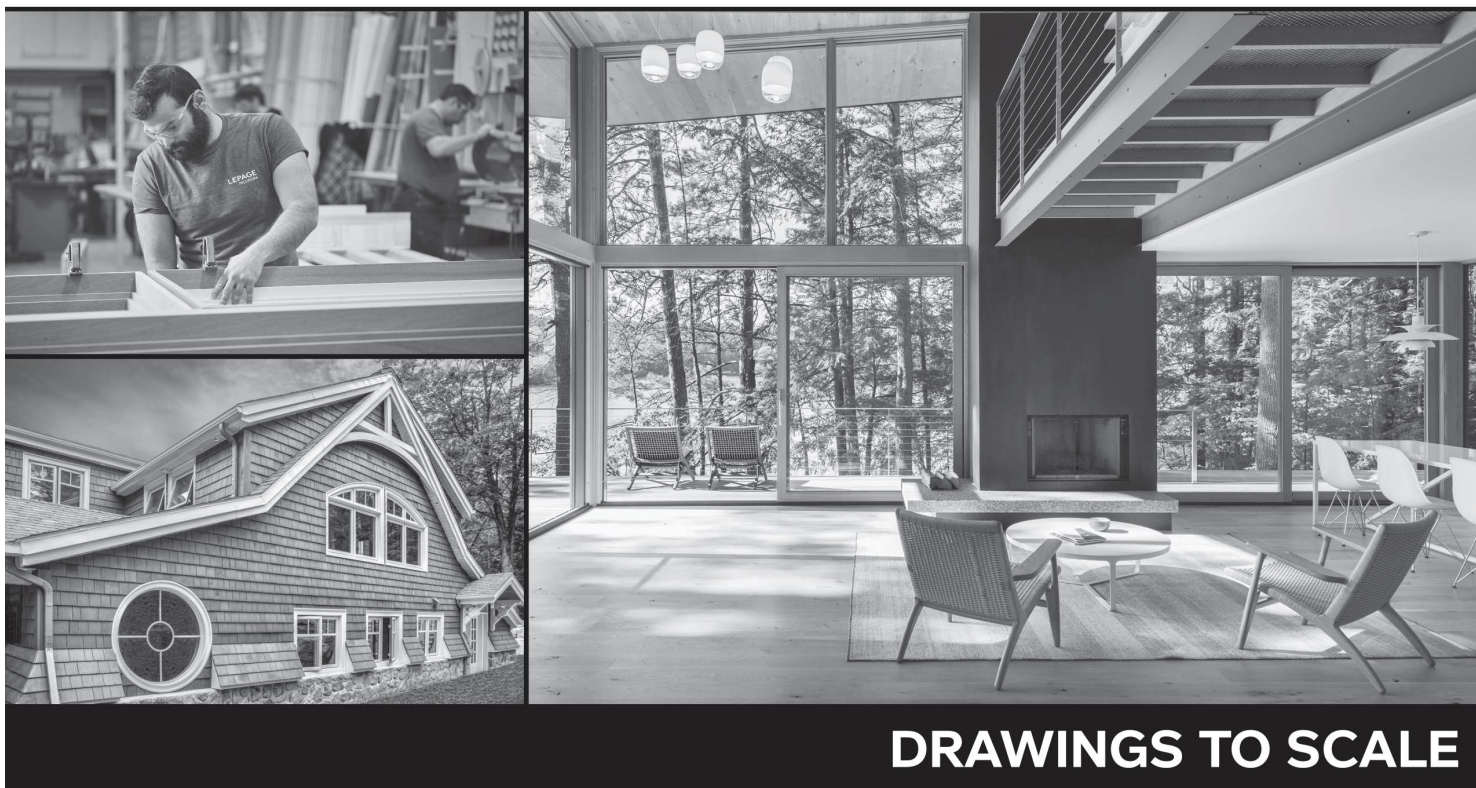

Authorized Dealer

Project name

Rye Annex PHS 1 Doors

Quote number

382898

Owner

Last modified date

2021-12-21 11:21

Item : 100-1 Quantity : 1
 Location : #1 Entry

Unit: -3676WF2A Wood door French Door 75.5W X 79.625H
 Perimeter : 26'

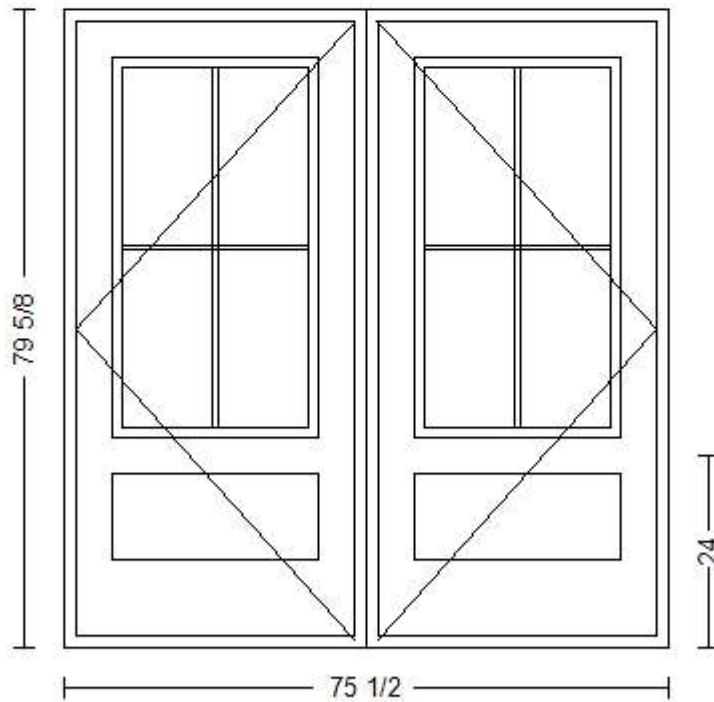

Frame Size : 75 1/2" W X 79 5/8" H

Grilles Visible Glasses : 12 15/32" W X 23 1/32" H
 317 X 585 mm

Ext. Casing : 75 1/2" W X 79 5/8" H

Rought Opening : 76 1/2" W X 80 1/8" H

Quote: 382898	Customer: CLEAR ADVANTAGE WINDOWS & DOORS, LLC	
Date: 12/21/2021	Job:	
Page: 2 / 4	Sales rep: <None>	Scale: 1/2" = 1'

LEPAGE
MILLWORK

Item : 200-1 Quantity : 1
 Location : #2 Vestibule

Unit: -3676WF2A Wood door French Door 75.5W X 79.625H
 Perimeter : 26'

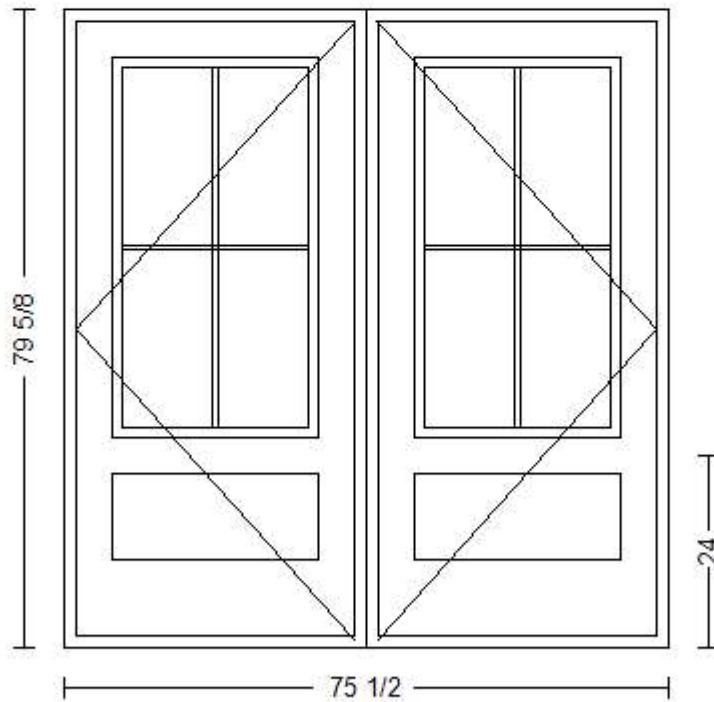

Frame Size : 75 1/2" W X 79 5/8" H

Grilles Visible Glasses : 12 15/32" W X 23 1/32" H
 317 X 585 mm

Ext. Casing : 75 1/2" W X 79 5/8" H

Rought Opening : 76 1/2" W X 80 1/8" H

Quote: 382898	Customer: CLEAR ADVANTAGE WINDOWS & DOORS, LLC	
Date: 12/21/2021	Job:	
Page: 3 / 4	Sales rep: <None>	Scale: 1/2" = 1'

LEPAGE
MILLWORK

Item : 300-1 Quantity : 1
 Location : #3 Rear

Unit: -3679WF11 Wood door French Door 38.625W X 82.625H
 Perimeter : 21'

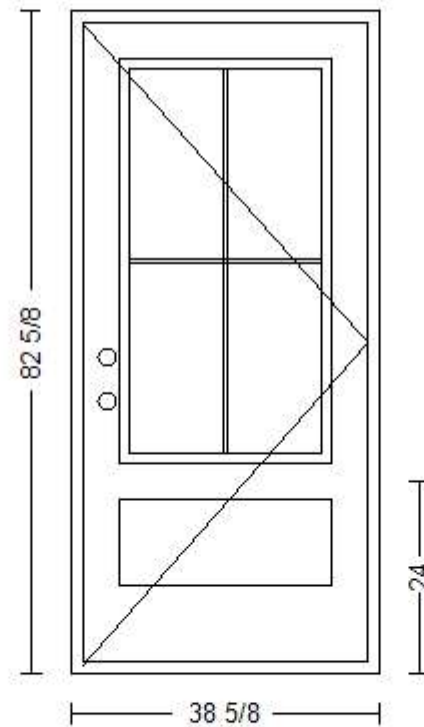

Frame Size : 38 5/8" W X 82 5/8" H

Grilles Visible Glasses : 12 17/32" W X 24 17/32" H
 318 X 623 mm

Ext. Casing : 38 5/8" W X 82 5/8" H

Rought Opening : 39 5/8" W X 83 1/8" H

Quote: 382898	Customer: CLEAR ADVANTAGE WINDOWS & DOORS, LLC	LEPAGE MILLWORK
Date: 12/21/2021	Job:	
Page: 4 / 4	Sales rep: <None>	

Quotation

Customer:

Ship to:

Doors PHASE 1

Order Date: Not ordered

Last Revision: 12/21/2021

Creation Date: 8/4/2021

C.S.: Kate Clement

P.O. no:

Date requested: 1/1/0001

Quotation no: **382898**

Job: Rye Annex PHS 1 Doors

Phone:

Fax:

100-1 **PK : 490**
75 1/2" L X 79 5/8" H

R.O.: 76 1/2" W X 80 1/8" H Ext. Cas.: 75 1/2" W X 79 5/8" H 1

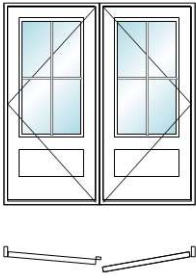

- PRODUCT = COMPLET UNIT, 3676WF2A - Wood door - French Door - 75 1/2" W X 79 5/8" H -
- Type : 10 outswing, right; (ast)
- FRAME = Frame 4 9/16" clad, Red Grandis, Ext.: Standard Color 430 Rainware white, Int.: First coat
- SASH = Silicone Seacoast Protection, Door 1, 2 : 600-G, Ext.: Flat panel clad, Int.: Flat panel natural, Middle check rail height : Standard 24", Other option for sash interior : Glass stop std (colonial), Slab Thickness (sash) : 2 1/4", Red Grandis, Stiles and top rail width : 5" (standard), Bottom Rail Height : 9" (standard), Sash model : Standard sash, Ext.: Ext. alum. standard Color 525 Black , Int.: First coat
- GLASS = Insulated (double), Tempered 2 sides, Low-e 272/argon (South region), Spacer: Technoform, Glass (Color Spacer): Bronze
- GRILLES = SDL 5/8" Ext: Standard (extruded) Int: Standard, same color as sash, With spacer: Bronze spacer, Grille pattern: Colonial
- HARDWARE = No Multipoint Lock, Without mortise lock
Hinges ball bearing 4 1/2 x4 1/2, Black
- OTHER OPTIONS = Bendable vinyl nail fin (D-068), Bronze handicap sill

Viewed from the outside

Location : #1 Entry

200-1 **PK : 490**
75 1/2" L X 79 5/8" H

R.O.: 76 1/2" W X 80 1/8" H Ext. Cas.: 75 1/2" W X 79 5/8" H 1

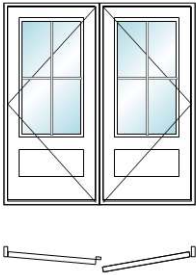

- PRODUCT = COMPLET UNIT, 3676WF2A - Wood door - French Door - 75 1/2" W X 79 5/8" H -
- Type : 10 outswing, right; (ast)
- FRAME = Frame 4 9/16" clad, Red Grandis, Ext.: Standard Color 430 Rainware white, Int.: First coat
- SASH = Silicone Seacoast Protection, Door 1, 2 : 600-G, Ext.: Flat panel clad, Int.: Flat panel natural, Middle check rail height : Standard 24", Other option for sash interior : Glass stop std (colonial), Slab Thickness (sash) : 2 1/4", Red Grandis, Stiles and top rail width : 5" (standard), Bottom Rail Height : 9" (standard), Sash model : Standard sash, Ext.: Ext. alum. standard Color 525 Black , Int.: First coat
- GLASS = Insulated (double), Tempered 2 sides, Low-e 272/argon (South region), Spacer: Technoform, Glass (Color Spacer): Bronze
- GRILLES = SDL 5/8" Ext: Standard (extruded) Int: Standard, same color as sash, With spacer: Bronze spacer, Grille pattern: Colonial
- HARDWARE = No Multipoint Lock, Without mortise lock
Hinges ball bearing 4 1/2 x4 1/2, Black
- OTHER OPTIONS = Bendable vinyl nail fin (D-068), Bronze handicap sill

Viewed from the outside

Location : #2 Vestibule

Customer:

Ship to:

C.S.:

Kate Clement

Doors PHASE 1

P.O. no:

Date requested: 1/1/0001

Quotation no: 382898

Job:

Rye Annex PHS 1 Doors

Phone:

Fax:

300-1 **PK : 490**
38 5/8" L X 82 5/8" H

R.O.: 39 5/8" W X 83 1/8" H Ext. Cas.: 38 5/8" W X 82 5/8" H 1

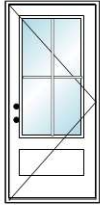

- PRODUCT = COMPLET UNIT, 3679WF11 - Wood door - French Door - 38 5/8" W X 82 5/8" H - Type : 4 outswing, right;
- FRAME = Frame 4 9/16" clad, Red Grandis, Ext.: Standard Color 430 Rainware white, Int.: First coat
- SASH = Silicone Seacoast Protection, Door 1 : 600-G, Ext.: Flat panel clad, Int.: Flat panel natural, Middle check rail height : Standard 24", Other option for sash interior : Glass stop std (colonial), Slab Thickness (sash) : 2 1/4", Red Grandis, Stiles and top rail width : 5" (standard), Bottom Rail Height : 9" (standard), Sash model : Standard sash, Ext.: Ext. alum. standard Color 430 Rainware white , Int.: First coat
- GLASS = Insulated (double), Tempered 2 sides, Low-e 272/argon (South region), Spacer: Technoform, Glass (Color Spacer): Bronze
- GRILLES = SDL 5/8" Ext: Standard (extruded) Int: Standard, same color as sash, With spacer: Bronze spacer, Grille pattern: Colonial
- HARDWARE = No Multipoint Lock, Without mortise lock, Drilled two holes 5 1/2" c/c (2 1/8"+2 1/8"), Back set 2 3/4
Hinges ball bearing 4 1/2 x4 1/2, Black
- OTHER OPTIONS = Bendable vinyl nail fin (D-068), Bronze handicap sill

Viewed from the outside

Location : #3 Rear

Item	Description	Qty	Unit Price	Total Price
------	-------------	-----	------------	-------------

Do not hesitate to contact us should you require any additional information

Total Item Quantity : 3

Quote valid for : 30 days

Customer signature : _____ Date: ___ / ___ / _____

LEPAGE

MILLWORK

True Artisans



DRAWINGS TO SCALE

Authorized Dealer

Project name

Rye Annex PHS 1

Quote number

382849

Owner

Last modified date

2021-12-21 11:19

Item : 100-1 Quantity : 8 Unit: 3222WH100-11 Wood H-100 Hung Series 37.625W X 52.875H
 Location : A01,A02,A03,A04,A05,A06,A07, Perimeter : 16'

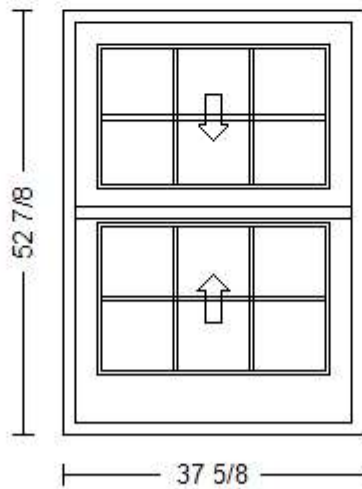

Frame Size : 37 5/8" W X 52 7/8" H

Grilles Visible Glasses : 9 3/4" W X 10 9/32" H
 248 X 261 mm

Ext. Casing : 37 5/8" W X 52 7/8" H

Rough Opening : 38 5/8" W X 53 3/8" H

Quote: 382849	Customer: CLEAR ADVANTAGE WINDOWS & DOORS, LLC	LEPAGE MILLWORK
Date: 12/21/2021	Job:	
Page: 2 / 4	Sales rep: <None>	

Item : 200-1
Location : B

Quantity : 2

Unit: 3222WH100-11 Wood H-100 Hung Series 37.625W X 52.875H
Perimeter : 16'

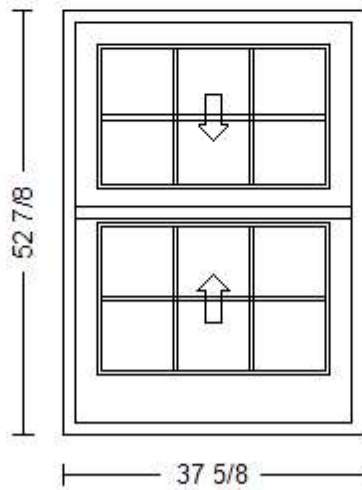

Frame Size : 37 5/8" W X 52 7/8" H

Grilles Visible Glasses : 9 3/4" W X 10 9/32" H
248 X 261 mm

Ext. Casing : 37 5/8" W X 52 7/8" H

Rough Opening : 38 5/8" W X 53 3/8" H

Quote: 382849	Customer: CLEAR ADVANTAGE WINDOWS & DOORS, LLC	LEPAGE MILLWORK
Date: 12/21/2021	Job:	
Page: 3 / 4	Sales rep: <None>	

Item : 300-1 Quantity : 2
Location : B08,B09

Unit: 1818WA11 Wood Awning - New Generation (A-100) 24W X 24H
Perimeter : 8'

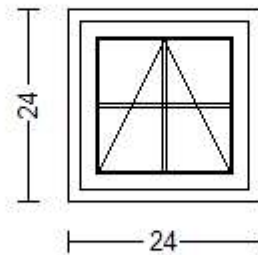

Frame Size : 24" W X 24" H

Grilles Visible Glasses : 8 7/16" W X 8 7/16" H
214 X 214 mm

Ext. Casing : 24" W X 24" H

Rought Opening : 25" W X 24 1/2" H

Quote: 382849	Customer: CLEAR ADVANTAGE WINDOWS & DOORS, LLC	LEPAGE MILLWORK
Date: 12/21/2021	Job:	
Page: 4 / 4	Sales rep: <None>	

Quotation

Customer:

Ship to:

Windows PHASE 1

Order Date: Not ordered
Last Revision: 12/21/2021
Creation Date: 8/3/2021
C.S.: Kate Clement
P.O. no:
Date requested: 1/1/0001
Quotation no: **382849**
Job: Rye Annex PHS 1

Phone: Fax:

100-1 PK : 490
37 5/8" L X 52 7/8" H

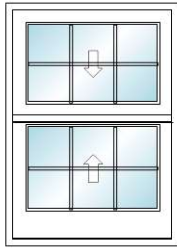

Viewed from the outside

Location : A01,A02,A03,
A04,A05,A06,
A07,A10

R.O.: 38 5/8" W X 53 3/8" H Ext. Cas.: 37 5/8" W X 52 7/8" H 8

- PRODUCT = COMPLET UNIT, 3222WH100-11 - Wood H-100 Hung Series - 37 5/8" W X 52 7/8" H - Double - Sash Split : Even
- FRAME = Frame 4 9/16" clad, Wood Pine : , Ext.: Standard Color 430 Rainware white, Int.: First coat
- SASH = Other option for sash interior : Glass stop std (colonial), Wood Pine, Sash model : Standard sash, Ext.: Ext. alum. standard Color 430 Rainware white , Int.: First coat
- GLASS = Silicone Seacoast Protection, Insulated (double), Low-e 272/argon (South region), Spacer: Technoform, Color spacer: Bronze
- GRILLES = SDL 5/8" Ext: Standard (extruded) Int: Standard Position: Top & bottom, same color as sash, With spacer: Bronze spacer, Grille pattern: Colonial
- SCREEN = Half Screen, Standard Color 430 Rainware white, Screen Mesh Type: Invisible (std)
- HARDWARE = Mixed(Surface Mount Locks&Recessed Tilt Assists), Without handle, Oil Rubbed Bronze locks, Locks Qty: 1, White Tilt assists
- OTHER OPTIONS = Bendable vinyl nail fin (D-068)

200-1 PK : 490
37 5/8" L X 52 7/8" H

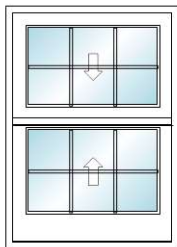

Viewed from the outside

Location : B

R.O.: 38 5/8" W X 53 3/8" H Ext. Cas.: 37 5/8" W X 52 7/8" H 2

- PRODUCT = COMPLET UNIT, 3222WH100-11 - Wood H-100 Hung Series - 37 5/8" W X 52 7/8" H - Double - Sash Split : Even
- FRAME = Frame 4 9/16" clad, Wood Pine : , Ext.: Standard Color 430 Rainware white, Int.: First coat
- SASH = Other option for sash interior : Glass stop std (colonial), Wood Pine, Sash model : Standard sash, Ext.: Ext. alum. standard Color 430 Rainware white , Int.: First coat
- GLASS = Silicone Seacoast Protection, Insulated (double), Low-e 272/argon (South region), Spacer: Technoform, Color spacer: Bronze
- GRILLES = SDL 5/8" Ext: Standard (extruded) Int: Standard Position: Top & bottom, same color as sash, With spacer: Bronze spacer, Grille pattern: Colonial
- SCREEN = Half Screen, Standard Color 430 Rainware white, Screen Mesh Type: Invisible (std)
- HARDWARE = Mixed(Surface Mount Locks&Recessed Tilt Assists), Without handle, Oil Rubbed Bronze locks, Locks Qty: 1, White Tilt assists
- OTHER OPTIONS = Bendable vinyl nail fin (D-068)

Customer:

Ship to:

C.S.:

Kate Clement

Windows PHASE 1

P.O. no:

Date requested: 1/1/0001

Quotation no: 382849

Job: Rye Annex PHS 1

Phone:

Fax:

300-1

PK : 490

R.O.: 25" W X 24 1/2" H

Ext. Cas.: 24" W X 24" H

2

24" L X 24" H

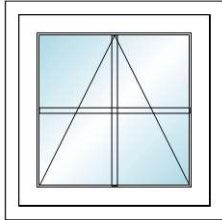

- PRODUCT = COMPLET UNIT, 1818WA11 - Wood Awning - New Generation (A-100) - 24" W X 24" H
- Vent
- FRAME = Frame 4 9/16" clad, Wood Pine : , Ext.: Standard Color 430 Rainware white, Int.: First coat
- SASH = 1 3/4 Sash, Other option for sash interior : Glass stop std (colonial), Bottom rail : Narrow bottom rail, Wood Pine, Sash model : Standard sash, Ext.: Ext. alum. standard Color 430 Rainware white , Int.: First coat
- GLASS = Silicone Seacoast Protection, Insulated (double), Low-e 272/argon (South region), Spacer: Technoform, Color spacer: Bronze
- GRILLES = SDL 5/8" Ext: Standard (extruded) Int: Standard, same color as sash, With spacer: Bronze spacer, Grille pattern: Colonial
- SCREEN = Screen, White (std), Screen Mesh Type: Invisible (std)
- HARDWARE = Traditional (Retractable) White (std)
- OTHER OPTIONS = Bendable vinyl nail fin (D-068)

Viewed from the outside

Location : B08,B09

Item	Description	Qty	Unit Price	Total Price
------	-------------	-----	------------	-------------

Do not hesitate to contact us should you require any additional information

Total Item Quantity : 12

Quote valid for : 30 days

Customer signature : _____ Date: ___ / ___ / _____

LEPAGE

MILLWORK

True Artisans



DRAWINGS TO SCALE

Authorized Dealer

Project name

Rye Annex PHS 2

Quote number

382909

Owner

Last modified date

2021-12-21 11:41

Item : 100-1 Quantity : 5 Unit: 3222WH100-11 Wood H-100 Hung Series 37.625W X 52.875H
 Location : B12,B13,B14,B15,B16,B17,B18 Perimeter : 16'

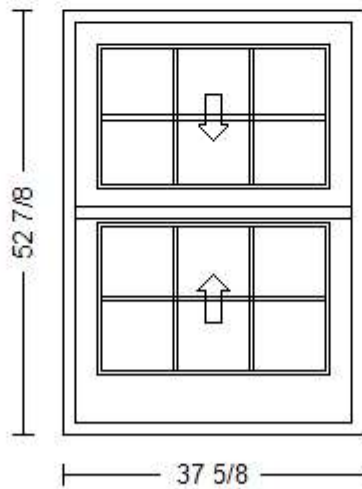

Frame Size : 37 5/8" W X 52 7/8" H

Grilles Visible Glasses : 9 3/4" W X 10 9/32" H
 248 X 261 mm

Ext. Casing : 37 5/8" W X 52 7/8" H

Rough Opening : 38 5/8" W X 53 3/8" H

Quote: 382909	Customer: CLEAR ADVANTAGE WINDOWS & DOORS, LLC	LEPAGE MILLWORK
Date: 12/21/2021	Job:	
Page: 2 / 5	Sales rep: <None>	

Item : 200-1 Quantity : 1
Location : D19

Unit: 2648WC11 Wood Casement - New Generation (C-100) 32W X 54H
Perimeter : 15'

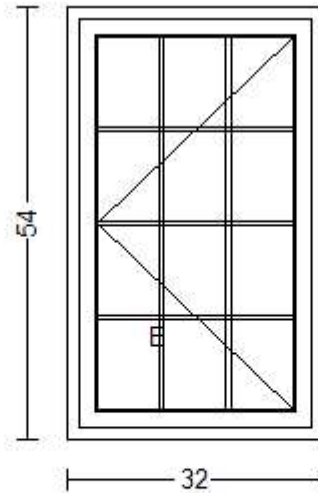

Frame Size : 32" W X 54" H

Grilles Visible Glasses : 8 1/16" W X 11 13/32" H
205 X 290 mm

Ext. Casing : 32" W X 54" H

Rought Opening : 33" W X 54 1/2" H

Quote: 382909	Customer: CLEAR ADVANTAGE WINDOWS & DOORS, LLC	LEPAGE MILLWORK
Date: 12/21/2021	Job:	
Page: 3 / 5	Sales rep: <None>	

LEPAGE

MILLWORK

True Artisans

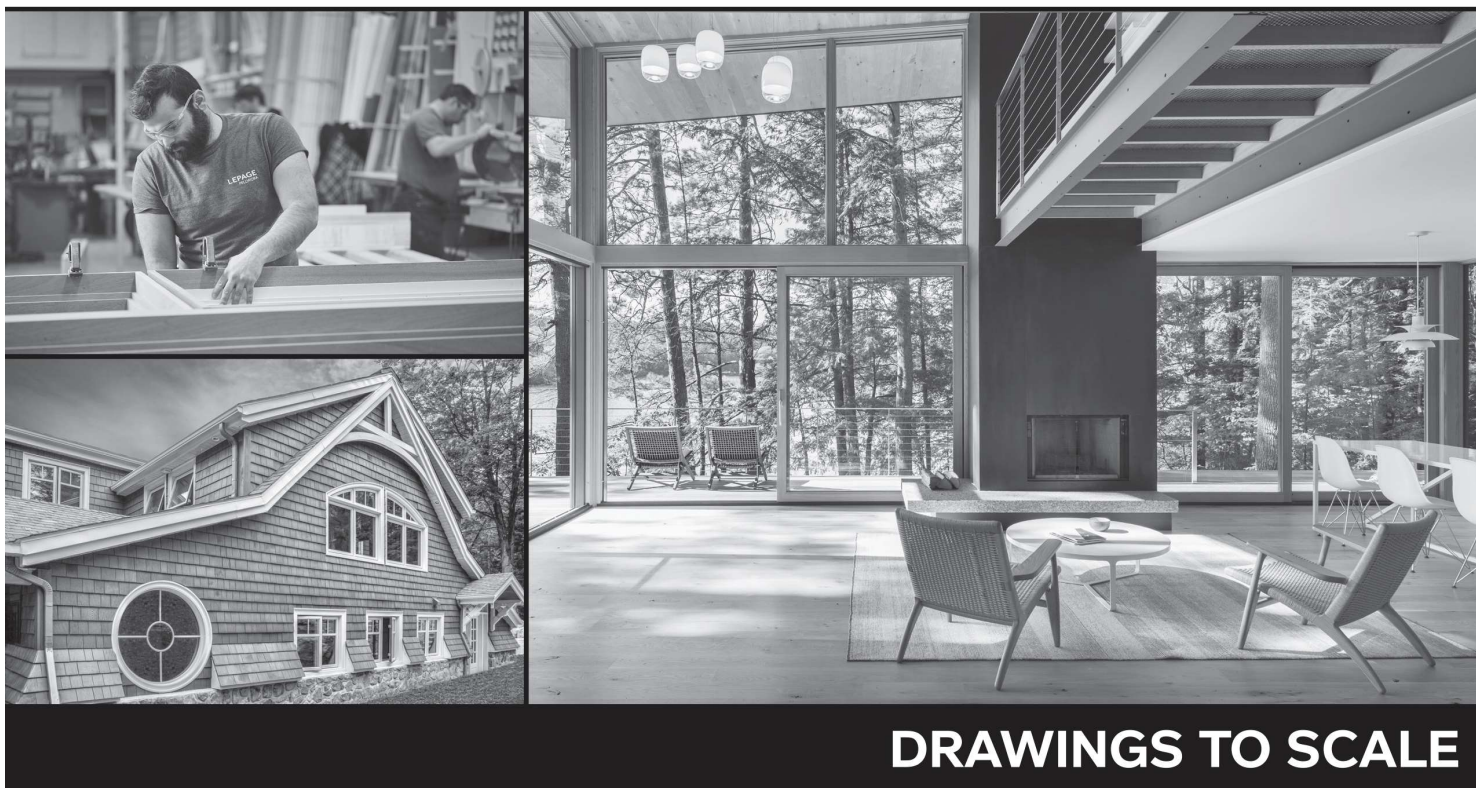

Authorized Dealer

Project name

Rye Annex PHS 2

Quote number

382909

Owner

Last modified date

2021-12-21 11:41

Item : 400-1 Quantity : 1
Location : C11

Unit: 3333WACSR Wood 36W X 36H
Perimeter : 12'

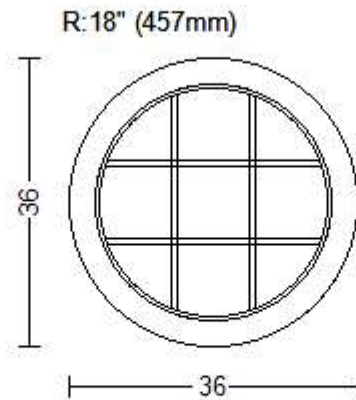

Frame Size : 36" W X 36" H

Ext. Casing : 36" W X 36" H

Rough Opening : 37" W X 36 1/2" H

Quote: 382909	Customer: CLEAR ADVANTAGE WINDOWS & DOORS, LLC	LEPAGE MILLWORK
Date: 12/21/2021	Job:	
Page: 5 / 5	Sales rep: <None>	

Quotation

Customer:

Ship to:

Windows PHASE 2

Order Date: Not ordered
Last Revision: 12/21/2021
Creation Date: 8/4/2021
C.S.: Kate Clement
P.O. no:
Date requested: 1/1/0001
Quotation no: **382909**
Job: Rye Annex PHS 2

Phone:

Fax:

100-1 **PK : 490**
37 5/8" L X 52 7/8" H

R.O.: 38 5/8" W X 53 3/8" H Ext. Cas.: 37 5/8" W X 52 7/8" H 5

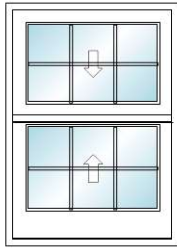

- PRODUCT = COMPLET UNIT, 3222WH100-11 - Wood H-100 Hung Series - 37 5/8" W X 52 7/8" H - Double - Sash Split : Even
- FRAME = Frame 4 9/16" clad, Wood Pine : , Ext.: Standard Color 430 Rainware white, Int.: First coat
- SASH = Other option for sash interior : Glass stop std (colonial), Wood Pine, Sash model : Standard sash, Ext.: Ext. alum. standard Color 430 Rainware white , Int.: First coat
- GLASS = Silicone Seacoast Protection, Insulated (double), Low-e 272/argon (South region), Spacer: Technoform, Color spacer: Bronze
- GRILLES = SDL 5/8" Ext: Standard (extruded) Int: Standard Position: Top & bottom, same color as sash, With spacer: Bronze spacer, Grille pattern: Colonial
- SCREEN = Half Screen, Standard Color 430 Rainware white, Screen Mesh Type: Invisible (std)
- HARDWARE = Mixed(Surface Mount Locks&Recessed Tilt Assists), Without handle, Oil Rubbed Bronze locks, Locks Qty: 1, White Tilt assists
- OTHER OPTIONS = Bendable vinyl nail fin (D-068)

Viewed from the outside

Location : B12,B13,B14,
B15,B16,B17,
B18

200-1 **PK : 490**
32" L X 54" H

R.O.: 33" W X 54 1/2" H Ext. Cas.: 32" W X 54" H 1

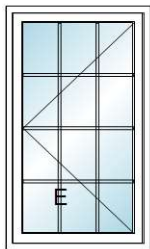

- PRODUCT = COMPLET UNIT, 2648WC11 - Wood Casement - New Generation (C-100) - 32" W X 54" H - Left
- FRAME = Frame 4 9/16" clad, Wood Pine : , Ext.: Standard Color 430 Rainware white, Int.: First coat
- SASH = 1 3/4 Sash, Other option for sash interior : Glass stop std (colonial), Bottom rail : Narrow bottom rail, Wood Pine, Sash model : Standard sash, Ext.: Ext. alum. standard Color 430 Rainware white , Int.: First coat
- GLASS = Silicone Seacoast Protection, Insulated (double), Low-e 272/argon (South region), Spacer: Technoform, Color spacer: Bronze
- GRILLES = SDL 5/8" Ext: Standard (extruded) Int: Standard, same color as sash, With spacer: Bronze spacer, Grille pattern: Colonial
- SCREEN = Screen, White (std), Screen Mesh Type: Invisible (std)
- HARDWARE = Traditional (Retractable) White (std)
- OTHER OPTIONS = Bendable vinyl nail fin (D-068)

Viewed from the outside

Location : D19

Customer:

Ship to:

C.S.:

Kate Clement

Windows PHASE 2

P.O. no:

Date requested: 1/1/0001

Quotation no: 382909

Job: Rye Annex PHS 2

Phone:

Fax:

300-1 **PK : 490**
32" L X 54" H

R.O.: 33" W X 54 1/2" H Ext. Cas.: 32" W X 54" H 1

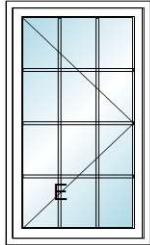

- PRODUCT = COMPLET UNIT, 2648WC11 - Wood Casement - New Generation (C-100) - 32" W X 54" H - Right
- FRAME = Frame 4 9/16" clad, Wood Pine : , Ext.: Standard Color 430 Rainware white, Int.: First coat
- SASH = 1 3/4 Sash, Other option for sash interior : Glass stop std (colonial), Bottom rail : Narrow bottom rail, Wood Pine, Sash model : Standard sash, Ext.: Ext. alum. standard Color 430 Rainware white , Int.: First coat
- GLASS = Silicone Seacoast Protection, Insulated (double), Low-e 272/argon (South region), Spacer: Technoform, Color spacer: Bronze
- GRILLES = SDL 5/8" Ext: Standard (extruded) Int: Standard, same color as sash, With spacer: Bronze spacer, Grille pattern: Colonial
- SCREEN = Screen, White (std), Screen Mesh Type: Invisible (std)
- HARDWARE = Traditional (Retractable) White (std)
- OTHER OPTIONS = Bendable vinyl nail fin (D-068)

Viewed from the outside

Location : D20

400-1 **PK : 490**
36" L X 36" H

R.O.: 37" W X 36 1/2" H Ext. Cas.: 36" W X 36" H 1

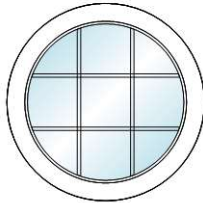

- PRODUCT = COMPLET UNIT, 3333WACSR - Wood Direct Set - New Generation (TF-100) - 36" W X 36" H ** TRANSOM/PICTURE** - With sash - Narrow bottom rail
- FRAME = Frame 4 9/16" clad, Wood Pine : , Ext.: Standard Color 430 Rainware white, Int.: First coat
- SASH = Other option for sash interior : Glass stop std (colonial) 1 3/4 sash, Wood Pine, Sash model : Standard sash, Ext.: Ext. alum. standard Color 430 Rainware white , Int.: First coat
- GLASS = Silicone Seacoast Protection, Insulated (double), Tempered 2 sides, Low-e 272/argon (South region), Spacer: Technoform, Color spacer: Bronze
- GRILLES = SDL 5/8" Ext: Standard (extruded) Int: Standard, same color as sash, With spacer: Bronze spacer, Grille pattern: Colonial
- OTHER OPTIONS = Bendable vinyl nail fin (D-068), Reinforced crating

Viewed from the outside

Location : C11

**** Approbation from R&D IS NEEDED ****

Item	Description	Qty	Unit Price	Total Price
------	-------------	-----	------------	-------------

Quotation

Customer:

Ship to:

Windows PHASE 2

Order Date: Not ordered
Last Revision: 12/21/2021
Creation Date: 8/4/2021
C.S.: Kate Clement
P.O. no:
Date requested: 1/1/0001
Quotation no: **382909**
Job: Rye Annex PHS 2

Phone: Fax:

100-1 PK : 490
37 5/8" L X 52 7/8" H

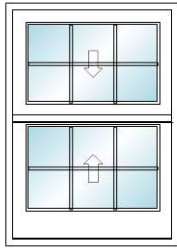

Viewed from the outside

Location : B12,B13,B14,
B15,B16,B17,
B18

R.O.: 38 5/8" W X 53 3/8" H Ext. Cas.: 37 5/8" W X 52 7/8" H 5

- PRODUCT = COMPLET UNIT, 3222WH100-11 - Wood H-100 Hung Series - 37 5/8" W X 52 7/8" H - Double - Sash Split : Even
- FRAME = Frame 4 9/16" clad, Wood Pine : , Ext.: Standard Color 430 Rainware white, Int.: First coat
- SASH = Other option for sash interior : Glass stop std (colonial), Wood Pine, Sash model : Standard sash, Ext.: Ext. alum. standard Color 430 Rainware white , Int.: First coat
- GLASS = Silicone Seacoast Protection, Insulated (double), Low-e 272/argon (South region), Spacer: Technoform, Color spacer: Bronze
- GRILLES = SDL 5/8" Ext: Standard (extruded) Int: Standard Position: Top & bottom, same color as sash, With spacer: Bronze spacer, Grille pattern: Colonial
- SCREEN = Half Screen, Standard Color 430 Rainware white, Screen Mesh Type: Invisible (std)
- HARDWARE = Mixed(Surface Mount Locks&Recessed Tilt Assists), Without handle, Oil Rubbed Bronze locks, Locks Qty: 1, White Tilt assists
- OTHER OPTIONS = Bendable vinyl nail fin (D-068)

200-1 PK : 490
32" L X 54" H

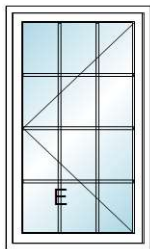

Viewed from the outside

Location : D19

R.O.: 33" W X 54 1/2" H Ext. Cas.: 32" W X 54" H 1

- PRODUCT = COMPLET UNIT, 2648WC11 - Wood Casement - New Generation (C-100) - 32" W X 54" H - Left
- FRAME = Frame 4 9/16" clad, Wood Pine : , Ext.: Standard Color 430 Rainware white, Int.: First coat
- SASH = 1 3/4 Sash, Other option for sash interior : Glass stop std (colonial), Bottom rail : Narrow bottom rail, Wood Pine, Sash model : Standard sash, Ext.: Ext. alum. standard Color 430 Rainware white , Int.: First coat
- GLASS = Silicone Seacoast Protection, Insulated (double), Low-e 272/argon (South region), Spacer: Technoform, Color spacer: Bronze
- GRILLES = SDL 5/8" Ext: Standard (extruded) Int: Standard, same color as sash, With spacer: Bronze spacer, Grille pattern: Colonial
- SCREEN = Screen, White (std), Screen Mesh Type: Invisible (std)
- HARDWARE = Traditional (Retractable) White (std)
- OTHER OPTIONS = Bendable vinyl nail fin (D-068)